

WELCOME TO ISCAR'S WORLD ²⁰²¹

Logical Extension

Machining with no boundaries [pg. 4]

Barrel Cutter Shapes a New Milling Trend

Efficient tools for machining 3D surfaces [pg. 12]

Choosing the Right Threading Insert

The most productive and common methods for producing threads [pg. 22]

Electrification in the Automotive Industry

ISCAR's cutting edge technology ahead of the industry [pg. 28]

NEOLOGIQ
MACHINING INTELLIGENTLY

The **Best** is Now
BETTER



Find The NEOLOGIQAL Tool For Your Application!

- The virtual tool advisor features advanced AI and 'Big Data' analytics
- Supports with complicated machining tasks and challenges
- Offers a wide range of functions and recommendations to operate machining centers
- Features online service 24/7 in more than 30 languages
- Functions according to ISO 13399



Table of Contents

Logical Extension	4
Barrel Cutter Shapes a New Milling Trend	12
Cast-Iron LogIQ	16
Choosing the Right Threading Insert	22
Electrification in the Automotive Industry	28
Machining Exotica	34

LOGICAL EXTENSION

Today, ISCAR introduces NEOLOGIQ, a logical extension to the previous campaign comprising of an entire range of advanced products and technological solutions for metal cutting tools - a quantum leap in the field.

What are the main targets of the NEO product lines?

ISCAR believes that NEOLOGIQ provides the answers to typical questions that modern metalworking faces today due to the latest changes in technology. Today, we are witnessing serious upheaval with far-reaching effects on manufacturing.

A distinct course for electric and hybrid cars will lead to a gradual abandonment of traditional cars with an internal combustion engine and a lot of parts that need to be machined.

A rise of accurate metal shaping methods, such as precision investment casting, precision forging, and 3D printing, which are all capable of shaping a part very close to its final profile, significantly diminishes the stock that is traditionally intended for chip-removal processes. A logical result of this is the considerably reduced share of machining operations in a part manufacturing cycle and this trend is already noticeable in the market today. Does it mean that a few good metalworking shops, factories, or even whole branches will abandon machining? Of course not, but the requirements for machining operations in engineering processes will be changed.



NEOLOGIQ

MACHINING INTELLIGENTLY



The role of productive and accurate cutting with a small allowance at high speeds and feeds will substantially grow, and metalworking industries will require a wide range of suitable tools that are expected to be more precise and durable. Digitized manufacturing, which is dictated by INDUSTRY 4.0 momentum, has its own demand and expects a

new level of a cutting tool "intellect" to be suitable for smart manufacturing. In preparing for the upcoming changes, ISCAR considers NEOLOGIQ as the next logical step to the cutting tool for the smart factory. **'Machining with no Boundaries'** is the motto of ISCAR's NEOLOGIQ products.



VIDEO



<https://www.youtube.com/watch?v=11-bJRC0v5Q>



VIDEO



<https://www.youtube.com/watch?v=x56Qy-oHL1E>



VIDEO



<https://www.youtube.com/watch?v=3Y87bmrM28o>

Logical Milling

ISCAR has an extremely wide range of HFM products to meet the requirements of a customer. However, even in this niche of products, there is place for new innovations.

LOGIQ4FEED, a family of high feed milling cutters carrying specific bone-shaped inserts, was enriched by new tools with greater insert sizes. These new tools have several features that substantially improve performance in high feed milling, especially when machining big cavities and pockets in steel parts.

Another HFM product that provides the customer with a reasonable cost saving solution is **NEOFEED**, a family of mills with square, double-sided inserts. This insert has 8 indexable cutting edges to use on cemented carbide and a dovetail-shaped insert pocket that ensures reliable mounting to withstand heavy loads to enable higher cutting data and increased productivity.



VIDEO



<https://www.youtube.com/watch?v=LYMXBSLXSmk>

The progress in 5-axis machining and CAD/CAM systems opens new horizons for machining 3D surfaces using barrel-shaped endmills. Although such endmills are still not common in the metalworking industry, advanced accurate metal shaping methods will dramatically increase the demand for these barrel-shaped endmills. Therefore, the development of effective "cutting barrels" is one of ISCAR's highest priorities. In the NEOLOGIQ product range, the barrel-shaped endmills are represented by two configurations: a solid carbide design and a **MULTI-MASTER** head. Combining **MULTI-MASTER** advantages with the precise barrel profile of a cutting-edge will result in a cost-effective and sustainable solution for finishing complex-shape surfaces by milling with minimum machining stock.

The **MULTI-MASTER** family has expanded the boundaries of its product range by introducing a new threaded connection size, T21, which enables increasing the nominal diameter of an exchangeable endmill head to 32 mm (1.25").

Intelligent Turning

In internal turning, a boring bar is the main factor of tool rigidity. A large bar overhang to diameter ratio leads to the tool deflection and vibrations; and is the bane of machining accuracy and surface finish.

WHISPERLINE, a family of anti-vibration boring bars, was developed to exceed the ratio bounds. These bars have a specially designed built-in absorber and a vibration-dampening mechanism that enables stable cutting with an overhang of up to 14 diameters.

WHISPERLINE bars are important elements of the new versatile modular system **NEOMODU**, providing a rich variety of assembly options for turning tools. A combination of different system units such as shanks, anti-vibration capsules, and interchangeable heads with indexable carbide inserts result in a tool assembly, which is maximally customized to a specific application.

NEOMODU INDEXABLE TURNING HEADS



WHISPERLINE ANTI-VIBRATION

VIDEO



<https://www.youtube.com/watch?v=KXzpNO0VIKM>

The shanks may be cylindrical, square, or with a polygon taper interface in accordance with ISO 26623 standard.

Speaking of new turning products, one cannot pass the **XNMG** insert. It is a beneficial combination of two famous ISO rhombic insert shapes: CNMG and DNMG inserts with 80° and 55° including angles. This intelligent integration resulted in the **XNMG 70°** angle insert that features improved clearance and ramping angles, when compared to the CNMG, and strengthened cutting corners against DNMG. The advantages of the new insert are visible in efficient multi-directional turning applications. The cartridges carrying insert XNMG, which are intended for mounting on **NEOMODU** units, are available as well.

NEOTURN ISOTURNING

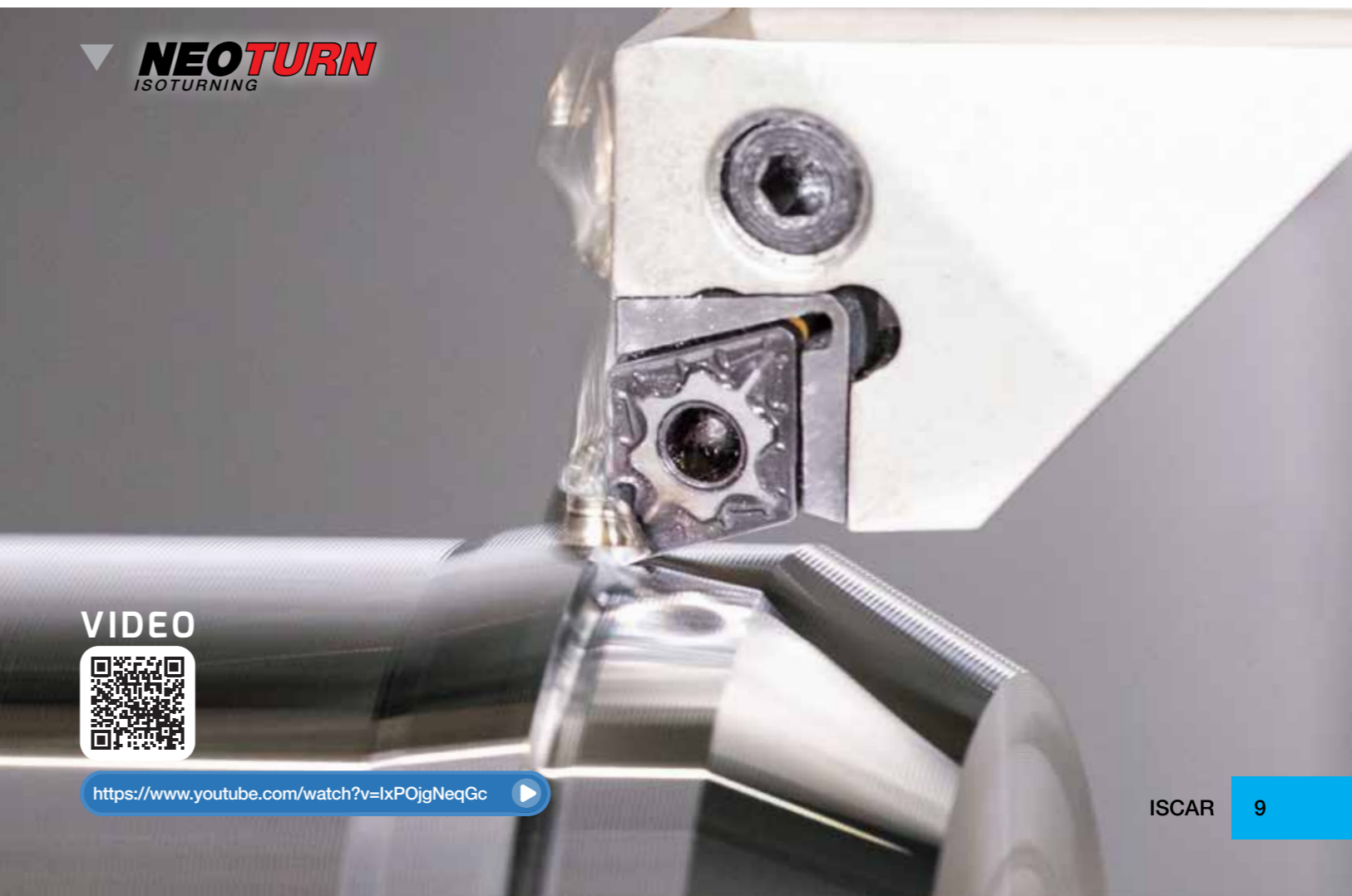

VIDEO



<https://www.youtube.com/watch?v=IxPOjgNeqGc>



VIDEO



https://www.youtube.com/watch?v=_3n8u4pfiRo

Competent Parting

ISCAR began its leadership with just parting tools. That is why every company's innovation in parting gains special interest. Adapters and holders occupy a prominent place among ISCAR's NEOLOGIQ parting products. The concept of the **LOGIQFGRIP** family is based on a 4-pocket adapter that is clamped in a reinforced tool block. High rigidity of such an assembly in combination with an inner high-pressure coolant supply (HPC) option facilitates productive cutting with extremely high feed rates.

In parting, one of the secrets to success is well-directed high-pressure cooling. If an adaptor has no HPC channels, mounting a specially designed crown-shaped accessory pushes the boundaries of application limits and enables effective pinpointed coolant flow to the active cutting edge of an insert.

Growing capabilities of modern multitasking machines and turning centers pushed the common boundaries of cutting strategies. Particularly, they brought the method of efficient turning along Y-axis. In quite a few cases, it is a worthy alternative to the traditional X-axis machining. In Y-axis turning, the dissipation of cutting force components is more favorable, and the main load is directed to a holder. The cutting process becomes more stable, and this facilitates increasing cutting data to improve productivity.

NEOLOGIQ
MACHINING INTELLIGENTLY

Efficient Holemaking

One of the more impressive product lines introduced in the LOGIQ campaign is **LOGIQ3CHAM**, a family of drills with replaceable carbide heads and three cutting edges, providing an effective tool for significantly increasing productivity for drilling depths up to five drill diameters.

In drilling, especially in drilling deep holes, efficient chip evacuation is extremely important. It is not enough to optimize chip control by an advanced design of the head geometry. The flute shape should ensure seamless chip flow. Undoubtedly, the need to organize three grooves weakens the body: when comparing a two-helical-flute drill of the same diameter, the three-flute body is less rigid. When the depth grows, longitudinal vibrations may occur, and this reduces tool life and adversely affects the accuracy and roughness of a machined hole. It was the decrease in stiffness that determined the barrier for the drilling depth and limiting it by five diameters maximum.

A new design of the three-flute drill body is based on a variable flute helix angle. Such a concept considerably improves the dynamic behavior of the drill and results in expanding the drilling depth boundaries: the maximum depth can now reach eight diameters.



ISCAR believes that new innovative solutions, which take machining to a whole new level, can become the new "Ariadne's thread". NEOLOGIQ, a logic of development for a new range of tools, has expanded the boundaries of intelligent machining.



VIDEO



<https://www.youtube.com/watch?v=sNFDeFYj2yo>

Barrel Cutter Shapes a New Milling Trend

Endmills featuring a cutting edge that is actually the segment of a large-diameter arc were introduced approximately 25 years ago. As the cutting-edge shape of these endmills is reminiscent of a barrel profile, terms such as "barrel milling cutters", "barrel endmills" or, in shop talk, often simply "barrels" soon became common when referring to these types of endmill.

At first, the use of these barrel-shape mills was limited more or less to a few specific applications, such as machining 3D surfaces of complex dies and turbomachinery components. However, advances in 5-axis machining and in CAM systems have significantly expanded the boundaries of barrel endmill applications.

Traditionally, ball-nose and toroidal cutters perform these machining operations. However, the large-diameter arc of the endmill cutting edge results in a substantial reduction of the cusp height generated between passes machined by a ball-nose or toroidal cutter. Another advantage of this type of cutting edge versus ball-nose and toroidal cutters is a significant increase in the distance between passes (a stepover or a stepdown, depending on the direction of a cutter displacement after every pass) - at least five times more without degradation of the surface finish parameters! This means that the number of passes

and, subsequently, machining time can be noticeably reduced. Increasing the distance between passes also improves tool life and, therefore, diminishes tool cost per part.

When compared with a common taper endmill, the taper barrel provides theoretically pinpoint contact between the major cutting edge and a machined surface that decreases accuracy errors and prevents recutting of a produced shape. The taper shape also contributes to reducing tool overhang – an important factor for improving tool performance.

Barrel and oval endmills are mainly utilized for cutting side surfaces. If machining a complex bottom surface is needed, a lens-shape endmill offers a good solution. This tool features barrel cutting edges on its end surface to ensure milling with a large stepover.

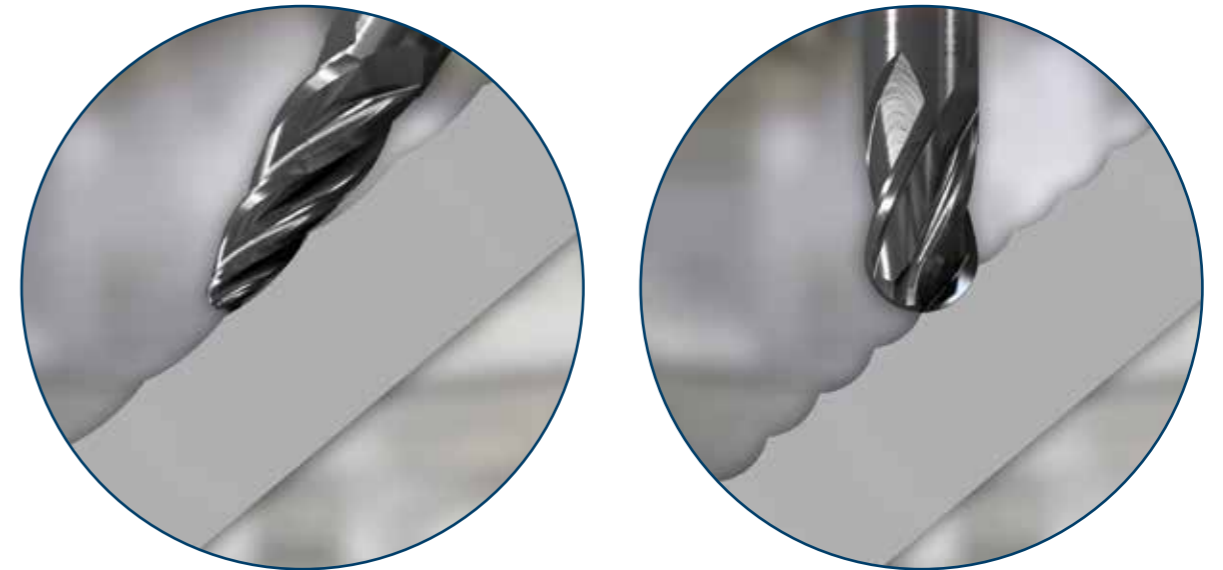

The barrel endmills - classical barrel-, oval- and lens-shaped cutters - provide efficient tools for machining 3D surfaces. Nevertheless, for a long time the complexity of CNC programming for applying barrel endmills was a constraining factor in actively integrating these promising tools into the appropriate branches of the metalworking industry. The growing use of 5-axis machine tools and the latest progress in CAM software has changed the situation dramatically, and today we see intensive utilization of barrel endmills in manufacturing various parts with geometrically complex surfaces. The main consumers of these "cutting barrels" are producers of aerospace, die and mold, medicine, turbine and compressor components.

The MULTI-MASTER Advantage

ISCAR offers oval- and lens- shape endmills in diameter ranges of 8 - 16 mm and .312" - .500". In addition to their availability in solid carbide design configurations, the new barrel endmills have been manufactured as exchangeable carbide heads with MULTI-MASTER threaded adaptation.

Additional factors in favor of applying the MULTI-MASTER concept to barrel endmills are economic feasibility and sustainability. Due to the complicated shape of its cutting edges, a barrel endmill is designed as a throwaway tool - when the wear limit is reached, the entire carbide endmill simply becomes waste. In contrast to solid tools, the MULTI-MASTER design provides a valuable option for careful and cost-effective use of cemented carbide materials. And, of course, a rich variety of available MULTI-MASTER shanks, reducers and extensions enables optimal assembly of a required tool from these elements. At present, barrel milling cutters are not in incredibly high demand by the metalworking industry; they are intended for very specific parts and effective application of such cutters requires highly engineered multi-axis machines and, especially important, leading-edge CAM systems. However, advanced workpiece manufacturing technologies (such as metal injection molding, 3D printing, investment casting and close-tolerance forging), innovative machine tools, and a quantum leap in digitizing of manufacturing will increase the needs for finishing complex surfaces with minimum machining stock. In this light, ISCAR's specialists estimate that barrel endmill consumption in the metalworking industry will increase exponentially, and cutting tool manufacturers should be shaping up to what is evidently a promising new industrial trend.

NEOLOGIQ
MACHINING INTELLIGENTLY



NEOBARREL ▶
PROFILE MILLING



CAST-IRON LOGIQ

As can be construed from its name, cast iron is intended for castings. Machining cast iron parts involves removal of non-uniform and variable stock - for example sand inclusions, casting skin, blowholes, hot tears and other casting defects, which affects cutting tools. From a machining point of view, the higher graphite content also has a disadvantage: it accelerates abrasion wear. This means that the cutting tools must have good wear resistance to ensure high productivity. It is also worth noting that the term "cast iron" may in fact refer to different types of ferrous alloy, for which machinability can vary significantly. The latter is often neglected, which can lead to wrong choice of cutting tools and incorrect definition of cutting data.

There are several types of cast iron. Grey, nodular and malleable cast iron form the application group K (red identification color) in accordance with the ISO 513 Standard classification. Hardened and chilled cast iron relate to group H (grey identification color). These specifications offer clear guidelines for manufacturers regarding the application of cutting tools - correct tool material, cutting geometry and cutting data selection.

Usually, machining ISO K cast iron is not a problem for manufacturers. Ferritic grey cast iron, for example, is an easy-to-cut material. However, machining ISO H cast iron is more difficult. Although similar to conditions for machining hard steels, the material's specific features demand appropriate solutions from cutting tool producers. In addition, some types of cast iron demonstrate a certain duality in their machinability, emphasizing the broadness and heterogeneity of the definition "cast iron".

For example, machinability of Ni-resist cast iron can be compared with grey cast iron; however, the required cutting geometry seems more suitable for austenitic stainless steel. Workpieces from austenitic ductile iron (ADI) are delivered in different material conditions and hardness level that impact on selecting right cutting tools. Machinability of ADI before hardening is sufficient and is similar to cutting high-alloy steel. Nevertheless, if this cast iron is machined in a high hardness condition, only the tools intended for the ISO H application group will meet the customer's expectations.

The situation with cast iron of high hardness in ISO H group is challenging. Machining cast iron with a hardness of HB 400...440 is usually less of a problem for manufacturers. However, the picture changes radically when dealing with hard abrasion-resistant high-chrome cast iron. The general hardness may be around HRC 52...54 but in the thin-wall areas of a machined part, the hardness can reach HRC 60 and even more. In combination with the high chrome content, it makes machining extremely difficult and significantly diminishes tool life.

Table 1 shows the averaged machinability rating for different cast iron types. Pearlitic grey cast iron, which is specified as 100% rating, provides a base for comparison.

Table 1- Machinability rating of cast iron (averaged data)

Material	Condition	ISCAR Mat. group*	Machinability %
Grey cast iron (GCI)	Ferritic	15	130
	Pearlitic	16	100
Nodular cast iron (NCI)	Ferritic-Pearlitic	17	75
	Pearlitic	18	70
Malleable cast iron (MCI)	Ferritic	19	115
	Pearlitic	20	93
Compacted graphite iron (CGI)		~17	80
Austempered ductile iron (ADI)	Soft	~10	80
	Hardened	41	35
Ni-resist austentic CI			90
Chilled cast iron	HB 400...440	40	50
Hardened cast iron	HB 550...600	41	25

* ISCAR material group in accordance with VDI 3323 standard

Selecting the most suitable cutting tool for machining cast iron should be based on a detailed study of a cast iron type and its hardness. Cutting tool application specialists, who are involved in selecting right tools, need to be fully accurate when specifying characteristics of the cast iron that is intended for machining. In turn, cutting tool manufacturers make

every effort to find the most effective solutions for machining cast iron, taking into account the diversity of the cast iron world. Among the main consumers of cast iron are the automotive, die and mold, machine tool, and heavy industries – all demanding increasingly efficient products from their cutting tool partners.



On a firm basis

The previously mentioned difficult-to-cut hard/high chrome cast iron produces serious barriers for machining productivity. A cutting tool experiences high mechanical and thermal loading. In milling this cast iron by cemented carbide tools, for example, a typical cutting speed is low: 40-50 m/min (130-160 sfm). Intensive heat generation often forces manufacturers to apply wet coolant. As a result, the tool operates under conditions of a heat shock effect, which considerably shortens the tool life.

ISCAR developed the DT7150 grade especially for this type of operation. DT7150 is a "DO-TEC" carbide grade that has a tough substrate and combines medium-temperature CVD and PVD coating processes. Due to its extremely high wear and chipping resistance, DT7150 provides customers with an effective tool material for cutting hard cast iron.

A fundamental significant change in productivity can be reached with the use of cubic boron nitride (CBN),

which enables a considerable increase in cutting speeds. In machining hard cast iron, for instance, the speeds are 2-5 times higher when compared with cemented carbide. ISCAR's high-performance milling cutters carrying tangentially clamped inserts with CBN tips are extremely popular in the automotive industry. For hard turning applications, the company expanded the range of CBN tipped ISO-type inserts for both continuous and interrupted cut

In ISO K applications (machining grey, nodular and malleable cast iron) in medium-duty loading, ceramic tools have demonstrated good results. Peripherally ground tangentially clamped TANGMILL milling inserts, made from the silicon nitride (Si3N4) grade IS8, ensures increasing cutting speed up to 3 times and provide excellent surface finish. In turning, cutting speeds of up to five times faster can be achieved by using the CVD-coated silicon nitride inserts, even for roughing operations.



The role of geometry

Cutting geometry and edge preparation are crucial for tool performance. There are several types of cutting-edge preparations: rounded, chamfered and so on. Although selecting the required preparation might appear to be a simple task, it is not so easy. Which width or angle of chamfering will be the most effective? How to ensure the defined angle during tool production? These questions are particularly critical when using ceramic or CBN inserts. The answers require appropriate professional skills and experience.

ISCAR CBN LINE ▶

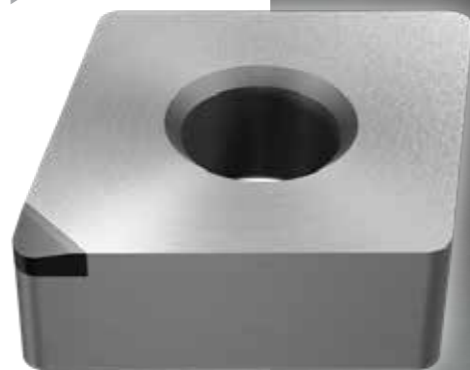

Extra fine finisher

ISCAR's recent launch of new products in its "LOGIQ" marketing campaign included the TANGFIN family of face milling cutters designed for extra fine surface finish which has been of great interest to producers of cast iron parts. The tangentially clamped inserts are positioned in a TANGFIN cutter with a gradual displacement in both radial and axial directions. The design causes each insert to cut only a small portion of the material. This concept, together with the high-rigidity tangential clamping principle and the long wiper edge of the insert, results in an impressive machined surface finish, with an Ra up to 0.1 μ (4 μ in) roughness parameter.

TANGFIN
FINISH MILLING



Customized solutions

The automotive industry is one of the largest producers of cast iron parts. In efforts to reduce cost per part in the mass production of automotive components, cutting tool manufacturers have developed customized highly engineered tools that perform specific machining operations with maximum productivity and lead to reducing the non-cutting component of cycle time.

A customized solution for machining steering knuckles provides an excellent example of these combined tools. ISCAR proposed this solution as a part of a turnkey project for one of the biggest car producers. The combined assembled tool performs several operations - cutting inner thread in holes for dust shield by tapping; milling two grooves (for snap ring and grease seal) by helical interpolation; and milling the outer face. The tool carries different radially and tangentially clamped inserts and has a tapping attachment with a misalignment compensating mechanism. The strict tolerance limits for linear dimensions ensure successful utilization of the tool in multi-spindle machines.

It turns out that machining cast iron is not such a simple matter after all, as is sometimes believed. Understanding the colorful world of this material and following the cast-iron rules for correct cutting tool application will ensure maximum efficiency and demonstrate the tool's "IQ" capabilities to achieve – and sustain – highly effective machining practices.



Choosing the Right Threading Insert

The production of thread connections is a common application in the metal working industry. Most metal working industries produce parts that are characterized by external or internal threads, from tiny dental screws to large thread joints for pipelines associated with the oil and gas industry.

There are a wide variety of thread types produced in National and International Thread Type Standards. Thread types differ in shape and dimension, where each standard defines a specific thread type. In many cases, a thread type standard characterizes a specific requirement for an industrial branch or main field of application. For example, UNJ and MJ thread type standards are associated with the Aerospace industry, and NPT and BSPT standards are associated with the oil and gas industry for pipelines, pipe connectors, and fittings.

Thread turning applications are one of the most productive and common methods for producing threads in rotary workpieces.

A successful thread type turning application depends on the selection of the right threading tool. There are simple steps to selecting an indexable threading tool correctly; first, identify if the thread is external or internal for which to choose a right- or left-hand tool.

After choosing the feed direction corresponding to the thread type, the thread designation will be determined according to the part drawing and application.



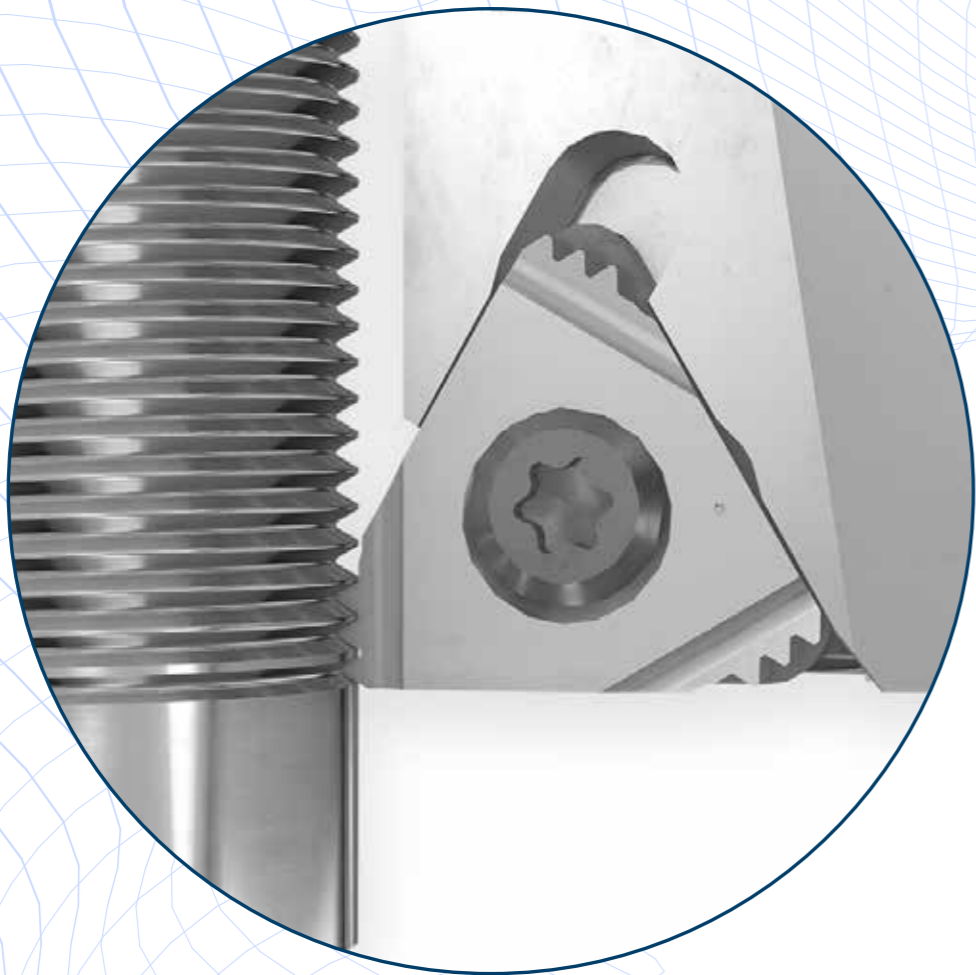

Typically, the thread designation is in accordance with metric or imperial systems depending on the thread type standard. In most cases, the thread designation includes the following parameters:

- Standard classification
- Thread pitch
- Number of starts
- Nominal diameter
- Thread length
- Tolerance class

The moment we have the values of the thread diameter, thread pitch, and the number of starts, we can calculate the thread lead (Helix) angle. This value will be very important for the next steps of the anvil selection if a possible solution relates to lay-down inserts. For such a tool, the found lead (Helix) angle determines the choice of anvils.

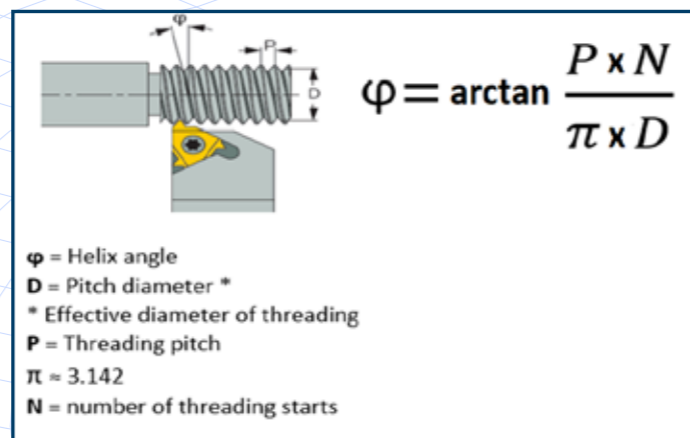

Aside from setting the correct lead (helix) angle, the anvil also supports the insert's cutting edge and protects the tool in case of insert breakage.

There are two types of threading inserts: full profile and partial profile.

Full profile inserts produce specific thread types, i.e., round (Rd) in accordance with DIN 405, British Standard Whitworth (BSW). **Partial profile inserts** require a precise pre-turning operation.

ISCAR's laydown family of inserts offers a wide range of thread type standards for both internal and external applications. Laydown inserts can be divided into 3 main types:

G-type – General duty inserts with deflector for machining various engineering materials, including the production of short chips.

M-type – Press-to-size inserts with sintered-shaped chipbreaker for efficient chip control. Although these inserts are press-to-size, they ensure the same thread accuracy as the

G-type insert. When threading at too small depths of cut, the chipbreaker efficiency drops and the M-type inserts are less recommended.

B-type – Peripherally ground inserts with a pressed chipbreaker. Efficient chip control with a sharp cutting edge is the ultimate combination for long chip materials and the first choice for ISO M stainless steel. When machining small parts, it is beneficial to use sharp-edged inserts with a chipbreaker to reduce cutting forces and consequently prevent vibrations.

Before using the multi tooth insert, it's important to ensure the thread area is not next to the shoulder, or that there's a wide release groove to complete a full thread along the part.

In addition to the ISO Standard laydown insert, ISCAR has a diverse group of captive pocket inserts. Captive pocket inserts are divided into internal threading and external threading types according to their application. Contrary to the ISO Standard laydown insert family, the clearance angles are already ground.

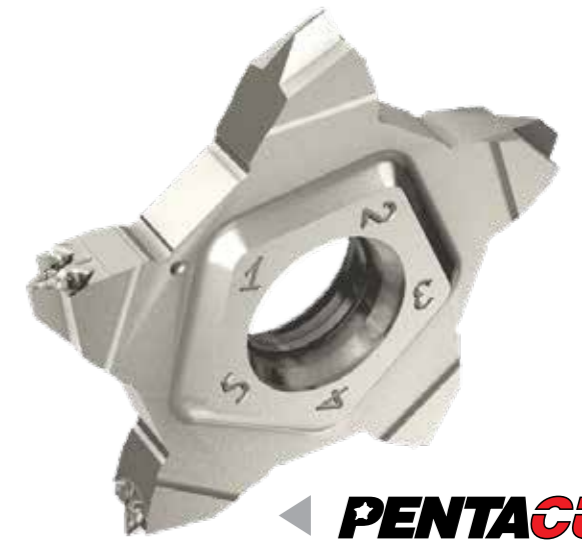

PENTACUT
THREADING LINE

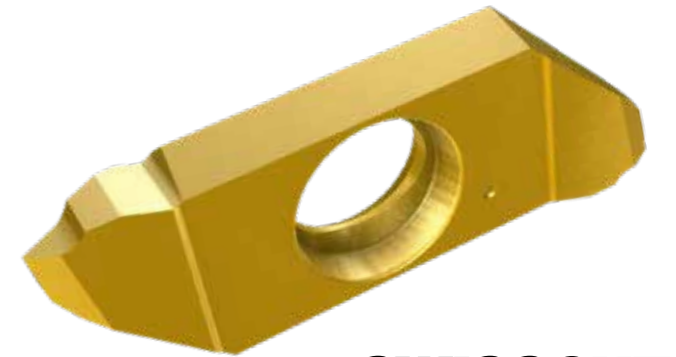

SWISSCUT
INNOVAL LINE

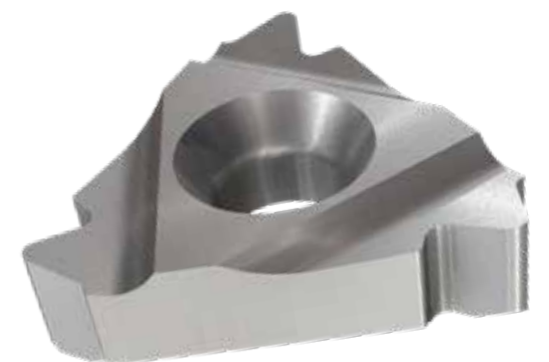

ISCAR THREAD
PIPE THREADING LINE



PENTACUT is one of ISCAR's successful captive pocket insert families. **PENTACUT** threading inserts have a wide assortment of benefits:

- ✓ 5 cutting edges and a cost-effective solution!
- ✓ Equipped with a molded chipbreaker for efficient chip control.
- ✓ Strong design for better conditions and productivity.
- ✓ Sub-family of partial profile inserts specially designed for working close to the shoulder with diverted cutting edges.
- ✓ For right- and left-hand threading.
- ✓ Ability to machine between walls.

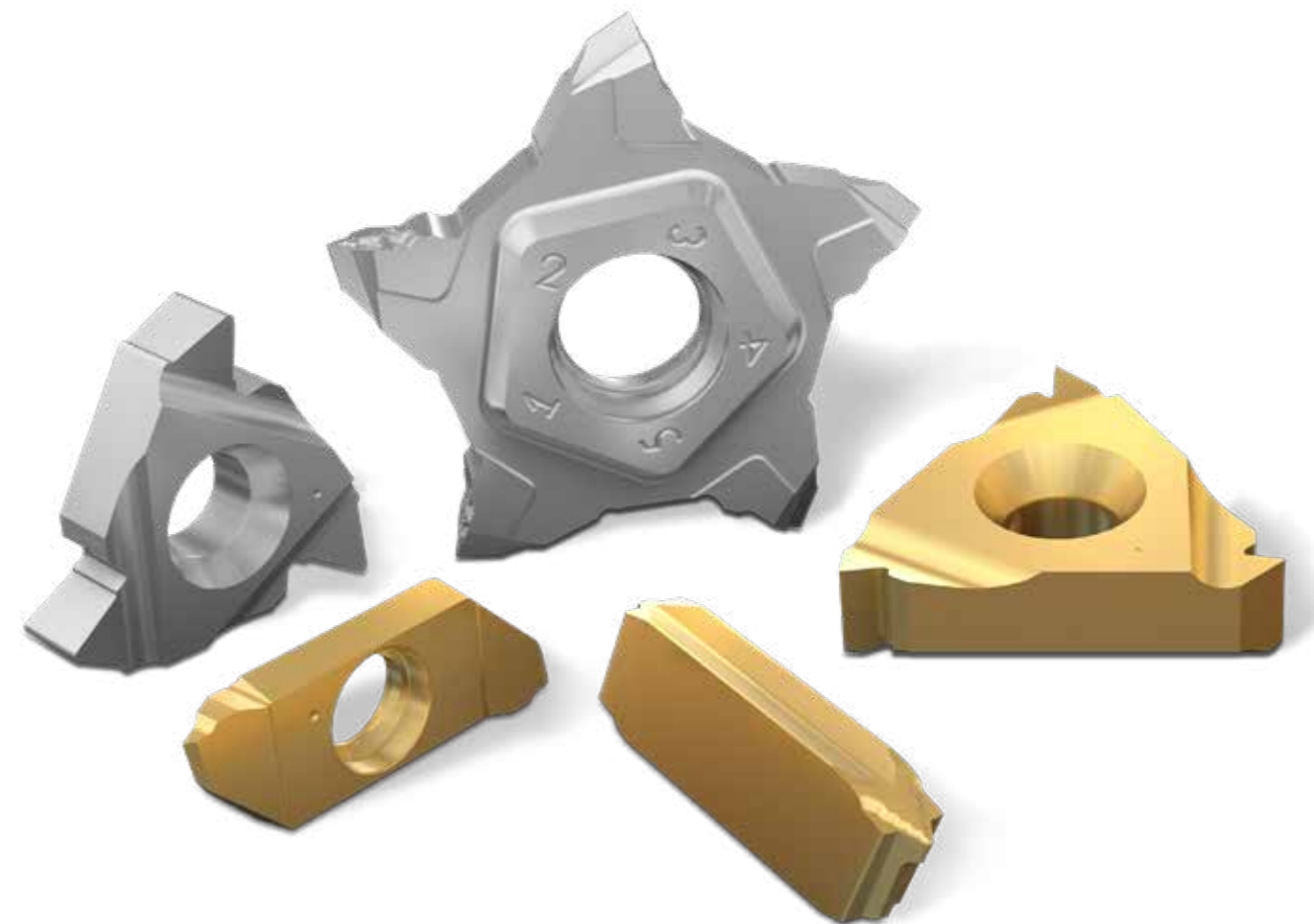

ISCAR's wide diversity of inserts covers most of the market's demand for threading standards. With advanced solutions per specific applications, ISCAR can offer tailor-made solutions according to any customer request.

Electrification in the Automotive Industry

Public awareness of global warming, together with a pressing concern to create and maintain a clean environment, has led to a series of legislations worldwide that is forcing automakers to decrease CO2 emissions. A rapid increase in battery electric vehicle (BEV) development, manufacture, and implementation, shows that electric vehicles are not only the future but are, in fact, the present.

The following is a list of some of the common component machining processes in the BEV industry and some of the leading possible machining solutions and recommendations for each part.

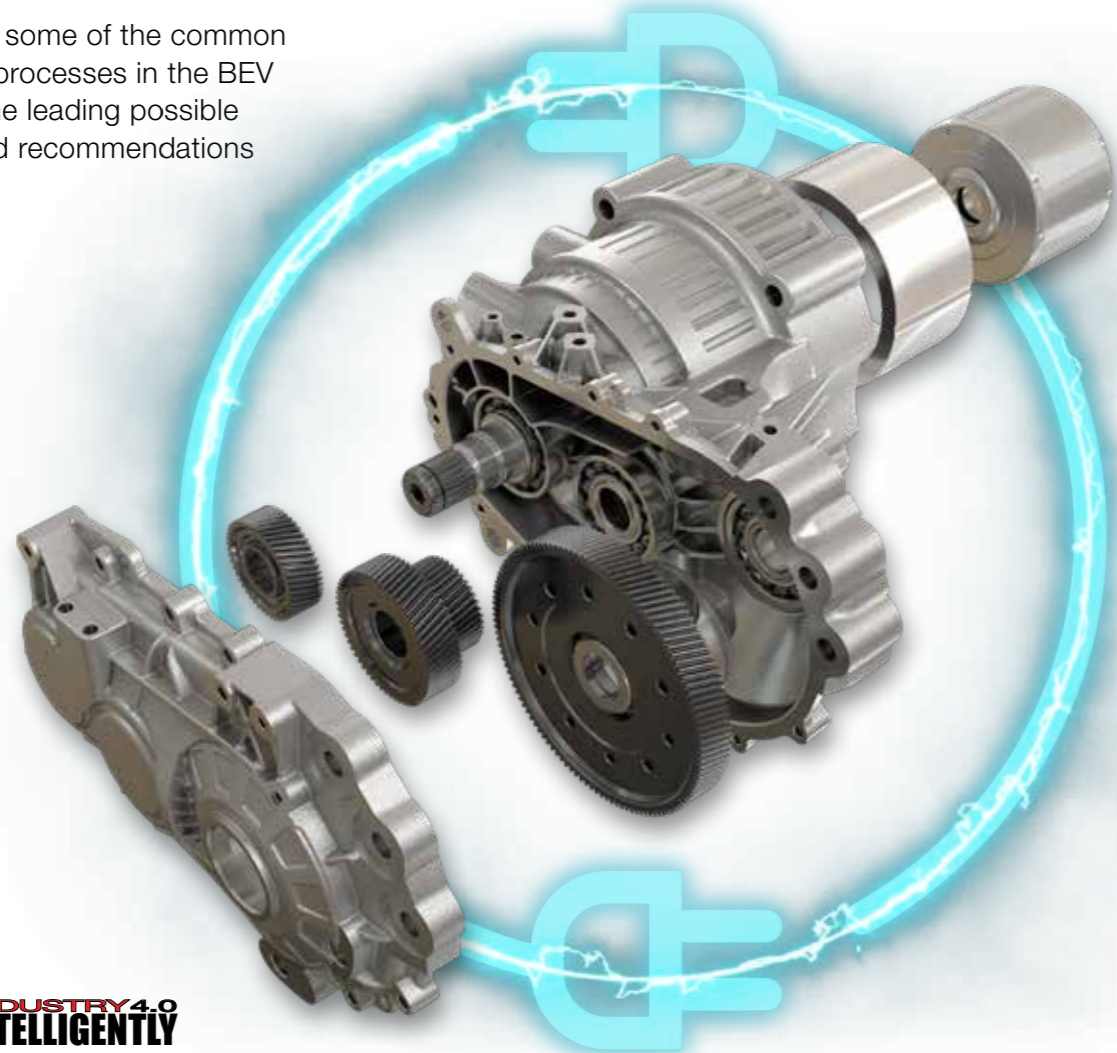

Stator housing machining

One of the most notable trends of the electric vehicle powertrain is its simplicity. There are far fewer moving parts compared to the traditional internal combustion engine (ICE), therefore manufacturing time, and cost dramatically drop when producing BEV's.

One of the main components of an electric motor is the motor (stator) housing made from aluminum. A special approach is needed to achieve this part's critical key characteristics of lightweight, durability, ductility, surface finish and precision, including geometrical tolerances. The partially hollow form represents an additional challenge and maintaining low cutting forces is essential for roughness and cylindricity requirements. ISCAR's complete machining solution for this process has facilitated the transformation from the standard costly lathe-based process to an economical machining center. Our aim is to reduce scrapped parts and reach an optimal CPK ratio. (Process Capability Index- producer's capability to produce parts within the required tolerance.)

Main Diameter Reaming

The most challenging operation in machining the Aluminum stator housing is the main diameter boring and reaming. Because of the trend to use low power machines, the tool's large diameter and long overhang require creative thinking to minimize weight and spindle load while maintaining rigidity. Exotic materials such as titanium and carbon fiber are used for the tool body, as well as the welded frame design.

The use of Finite Element Method (FEM) helps resolve the obstacles associated with this challenging application by enabling the consideration of many parameters, such as cutting forces, displacement field during machining, natural frequency, and maximum deformation.

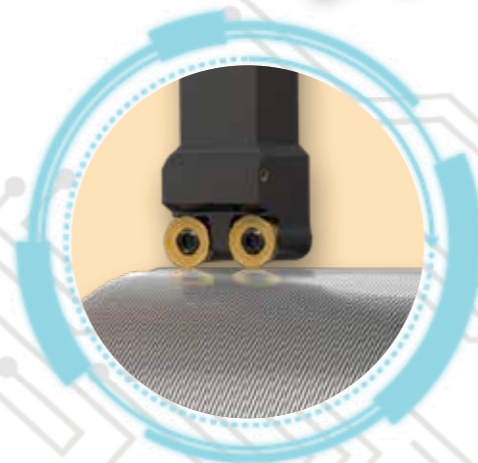
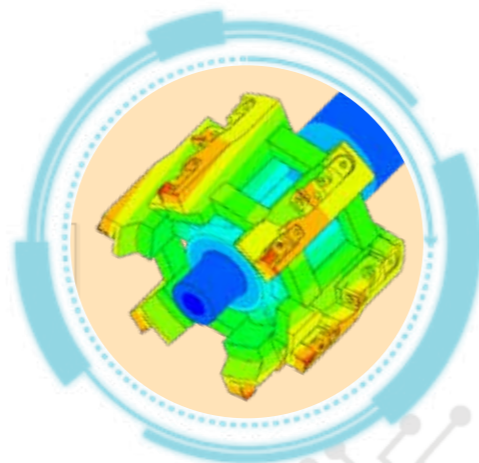
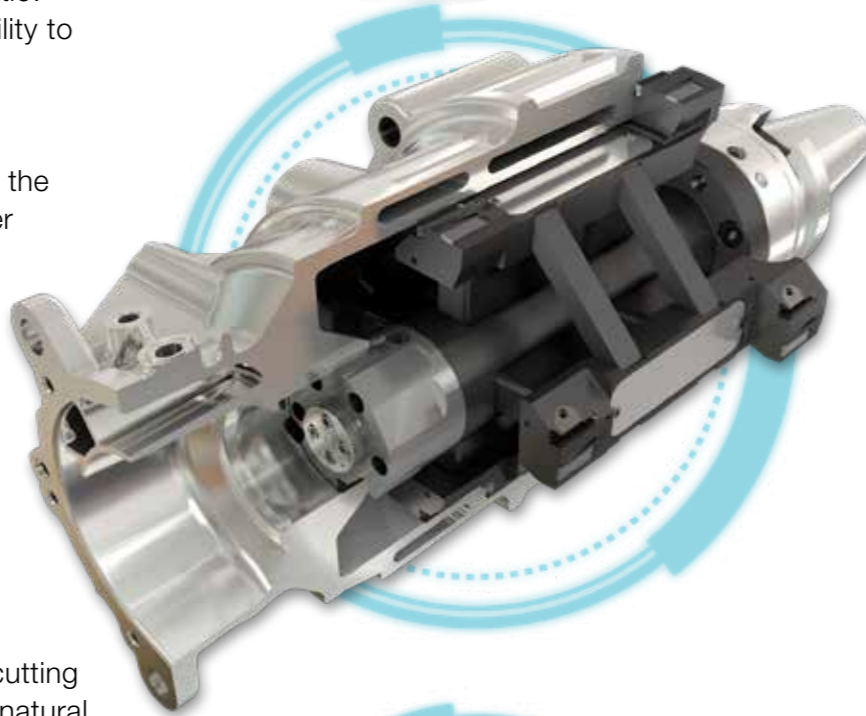
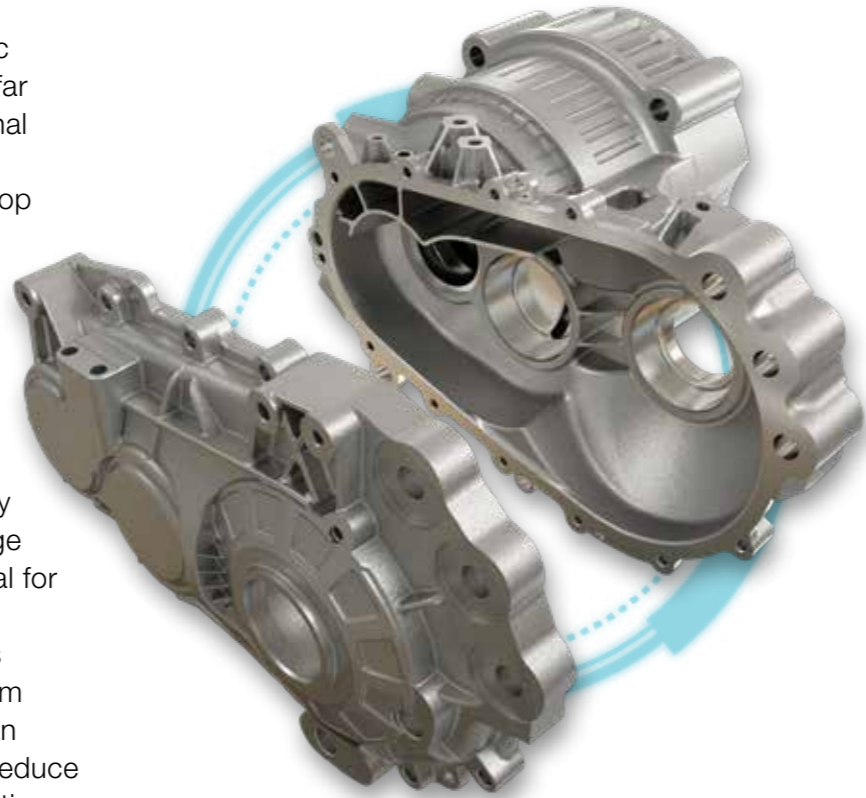

Bearing Seat Reaming After Assembly

Unlike the ICE, the electric motor generates its maximum torque from a standing start. This means it does not require a complex transmission system to operate. A simple reduction gear is enough for the average electric vehicle. This reduction gear sits between the stator housing and the gear cover.

To maintain concentricity between bearing seats of the stator and gear cover, the reaming operation must be performed in the same machining sequence. For this operation, ISCAR provides a special "push and pull" reaming type tool with adjustable PCD blades that manage to retain the geometrical tolerances required in different inner diameters on this Aluminum part.

Rotor Turning

The rotor consists of many stacked plates of electric steel. Lamination sheets are used instead of a solid body to reduce current loss. The surface must be completely clean of chips, oil, water, dust or dirt, and coolant fluid cannot be used, only air. This is a challenge as a lot of heat is generated on the cutting area and the fragmented chips stick to the surface. Surface finish requirements for this interrupted turning operation remain strict.

ISCAR has overcome these challenges by developing a combined tool with coolant holes both on top and bottom of the cutting edge to cool and blow away the chips. The two round inserts are positioned for semi finish and finishing operations, generating an excellent surface finish.



Battery Case Drilling

As batteries are replacing fuel as an energy source for vehicles, the battery case is an integral component of the car design. Large size and light weight requirements make aluminum a natural choice for manufacturing this part. But, when dealing with high-end supercars or sport cars, every unit of weight counts. That is why some automakers turn to the use of carbon fiber reinforced plastic (CFRP), which offers lighter weight, high rigidity, and lower thermal conductivity than aluminum.

ISCAR has a wide array of tools specially designed to machine aluminum and CFRP, which provide productive and economical solutions for any application. For example, for the required drilling holes, the SUMOCHAM indexable head drilling line offers a variety of geometries suited for specific materials. For drilling Aluminum, ICN heads are designed with a sharp cutting edge and polished rake face. ICG heads feature a chip splitter for better chip removal when working with a long overhang. For drilling CFRP, special ICF geometry is available with diamond coating - this drilling head is designed to overcome all the typical CFRP machining failures such as delamination.

SUMOCHAM
CHAMDRILL LINE



ICN - Std. range
Ø10-19.5 (.394-.768")



ICG - Std. range
Ø14-25.9 (.551-1.020")

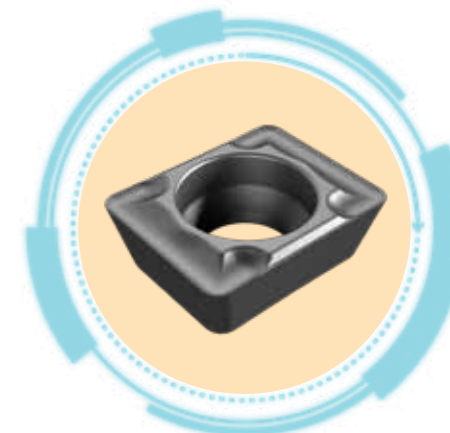

AOGT - Small sharp
polished insert



Using ISCAR's cutting edge technology and innovative solutions will keep the part manufacturer ahead of the industry and help him adapt fast to the growing changes for a cleaner, greener, and healthier place to live in.

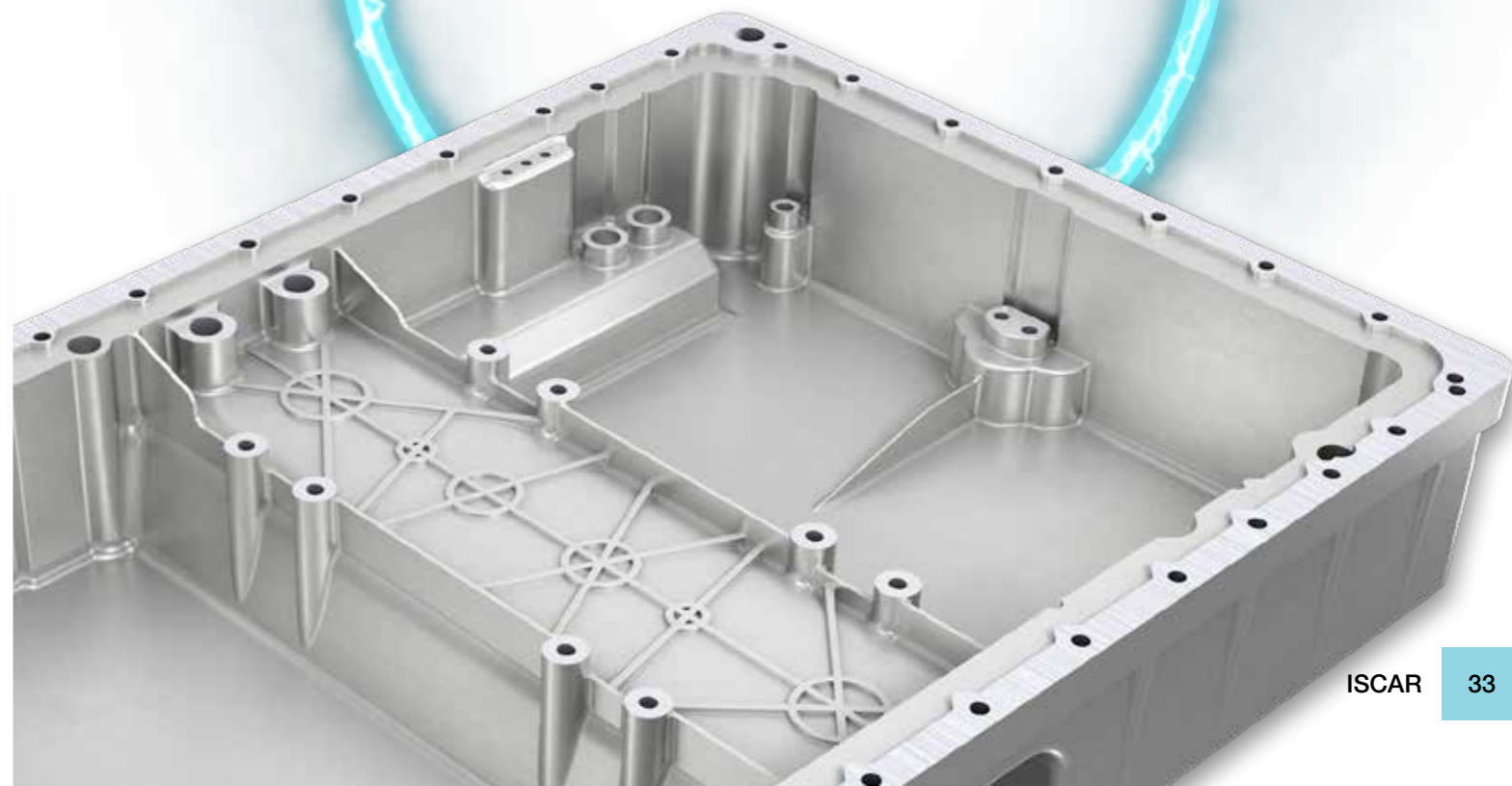

MACHINING EXOTICA

Mainstream engineering materials are iron-based alloys such as steel, stainless steel, and cast iron. Another group of regularly used materials includes alloys based on nonferrous metals, such as aluminum alloys, brass, and bronze. In addition, there are exotic types of material that were developed to answer specific demands. These exotic materials feature a dedicated application; they are rare and not commonly used and are generally more expensive to fabricate.

A strict agreed definition of an exotic material does not exist. Many experts refer to them as metals like Beryllium, Zirconium, etc. and their alloys, ceramics, composites, and superalloys. When considering the use of structural materials, superalloys and composites should be distinguished first. The metalworking industry mainly deals with these types of materials due to several reasons, one of which is machining exotic materials is problematic. Superalloys, or more specifically, high temperature superalloys (HTSA), are intended for operating under a heavy mechanical load in combination with high temperatures. They are largely used in gas turbines and in various valves and petrochemical equipment. The "exoticism" of superalloys is their metallurgical design, which provides high creep resistance to keep strength at high temperatures. According to the main component, HTSA can be divided into three groups: Nickel (Ni)-, Cobalt (Co)-, and Iron (Fe)-based superalloys. A superalloy chemistry, especially in case of Ni- and Co-based HTSA, results in poor machinability.

Composites are multicomponent materials. When compared with a traditional engineering material, such as steel or Aluminum, composites workpieces are nearer-to-net shape and do not require significant material removal. Nevertheless, the components of a composite have different properties, and when combined, they produce a heterogeneous structure that makes machining problematic. The process of machining composites differs from machining metals and it often looks more like shattering than cutting. High composite abrasiveness can lead to intensive tool dulling, and various performance problems such as a degradation of accuracy or non-repairable machining defects.

An impressive leap forward in 3D printing, which may significantly diminish machining operations, looks very promising. But there is one "exception", which still limits taking full advantage of the considerable increase of machine tool capabilities. This "exception" is the cutting tool. Despite the distinct progress, cutting tools remain the bottleneck for machining efficiency. Hence, the plans of a breakthrough in the productive machining of exotic materials have much to do with the cutting tool. Recent ISCAR developments, which were introduced during the last years, give a good example of such products and ISCAR's attempt to resolve the existing bottleneck and find new ways to move forward.





Cutting Diamond

In manufacturing parts from composites, drilling is widely regarded as the major cutting operation. Improving capabilities of drilling tools has had a direct impact on the effectiveness of machining composites and composite stacks.

Most recently, ISCAR introduced a series of new solid drills, in the diameter range of 3.3-12 mm (.130-.500"), which are specially designed for composites. The common feature of these tools is the use of polycrystalline diamond (PCD) or diamond coating to ensure high abrasion wear resistance. There are several types of these new drills; one of them is based on using a PCD nib as a central point of a drill, and another type has a diamond wafer. Both drill types offer a large area for multiple regrinding.

The third type of drills are solid carbide tools with a diamond-coated cutting area. Their wavy cutting edge facilitates reducing burr formation, specifically when drilling carbon fiber reinforced plastics (CFRP) and CFRP-Aluminum stacks.



Exotic for Exotic: advantageous ceramics

Cemented carbide is still the main cutting material for machining. Introducing carbide tools revolutionized the metalworking industry ensuring a significant growth of productivity due to sharply increased cutting speeds. However, despite this, even today cutting speeds for difficult-to-machine Ni- and Co-based high-temperature superalloys (HTSA) are low: typically within the range of 25-50 m/min (80-160 sfm). How do we expand the speed boundaries?

Exotic ceramic materials have already found themselves as cutting materials. Using exotic ceramic material ensures a totally different level of cutting speeds. For example, machining the superalloys by ceramic tools, the cutting speed 1000 m/min (3300 sfm) is completely real. Therefore, ceramic tools become more and more common in machining HTSA. Recently, ISCAR developed a family of indexable shell mills carrying double-sided inserts made from

ceramics. The mills are intended mostly for rough and semi-finish machining of planes and 3D surfaces at extremely high cutting speeds. The economical double-sided insert design provides high ceramics utilization. The inserts are made from several ceramic grades such as "black" ceramics, whisker reinforced ceramics and SiAlON (a type of silicon-nitride-based ceramics). Applying the new mills is directed on maximizing metal removal rate (MRR) and dramatic reduction in cycle time.

One more example of successful usage of cutting ceramics is another of ISCAR's latest products: a family of solid endmills from SiAlON. The endmills were designed specifically for productive rough machining Ni-based superalloys such as various grades of Inconel, Incoloy, Haynes, etc. in the aerospace industry. In comparison with typical solid carbide endmills, SiAlON endmills allow an increase in cutting speed of up to 50 times!

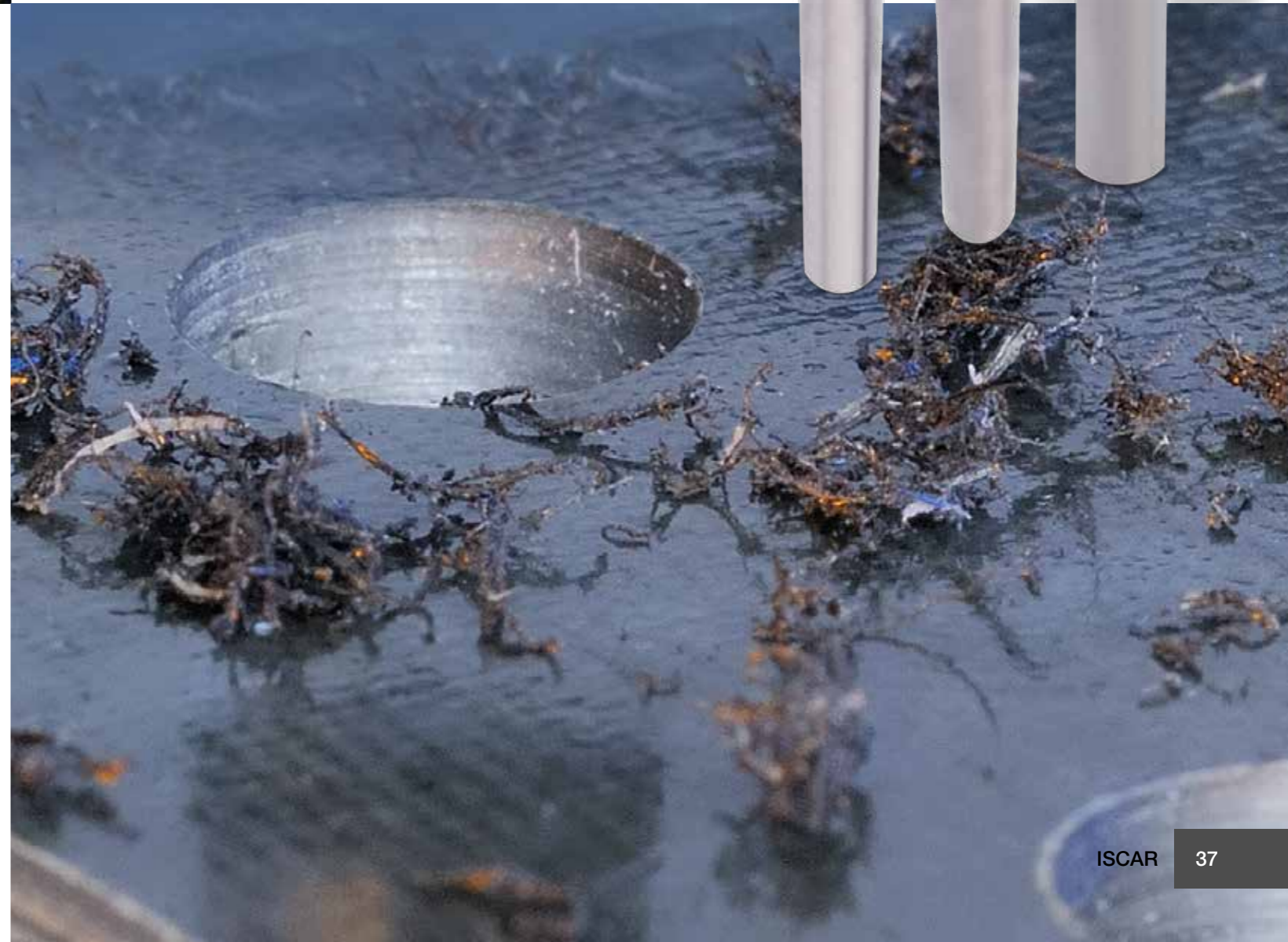

Coolant Solver

In machining exotic superalloys, effective coolant supply is a cornerstone of success. Pinpointed high-pressure cooling (HPC) can be a significant tool to improve cutting performance. It is a real source for greater tool life, better chip control, and higher productivity.

One of the latest ISCAR's developments is a family of turning tools with ISO-type indexable inserts. The tool design utilizes an upper clamp for reliable securing of the inserts even during heavy and interrupted cuts. The previous turning tools with the HPC option had a lever clamping mechanism as an upper clamp would obstruct a jet of coolant from reaching the cutting edge.

The newly developed tools integrate a hollow upper clamp that allows for solving two problems:

- strong and rigid insert clamping
- eliminating any obstacle for the coolant jet on its way to the cutting edge

Hence, the clamp, which serves in the new tools as a coolant nozzle, received an additional important functional feature.

The new products with through-tool coolant supply are beneficial not only in machining with HPC. Their applying to turning with conventional external "low" pressure cooling (10-15 bars) also provides better performance.

In parting and grooving, especially in deep grooving, efficient chip forming has crucial significance. Pinpointed high-pressure cooling of a cutting edge significantly diminishes chip jamming and reduces built-up edge. Within the past year, ISCAR expanded the range of its HPC products by introducing new face grooving tools with HPC option. These tools are suitable for coolant pressure of up to 140 bars.

▼ **JETRETURN**
RIGID CLAMP



▼ **TANGGRIP**
FACE MACHINING LINE



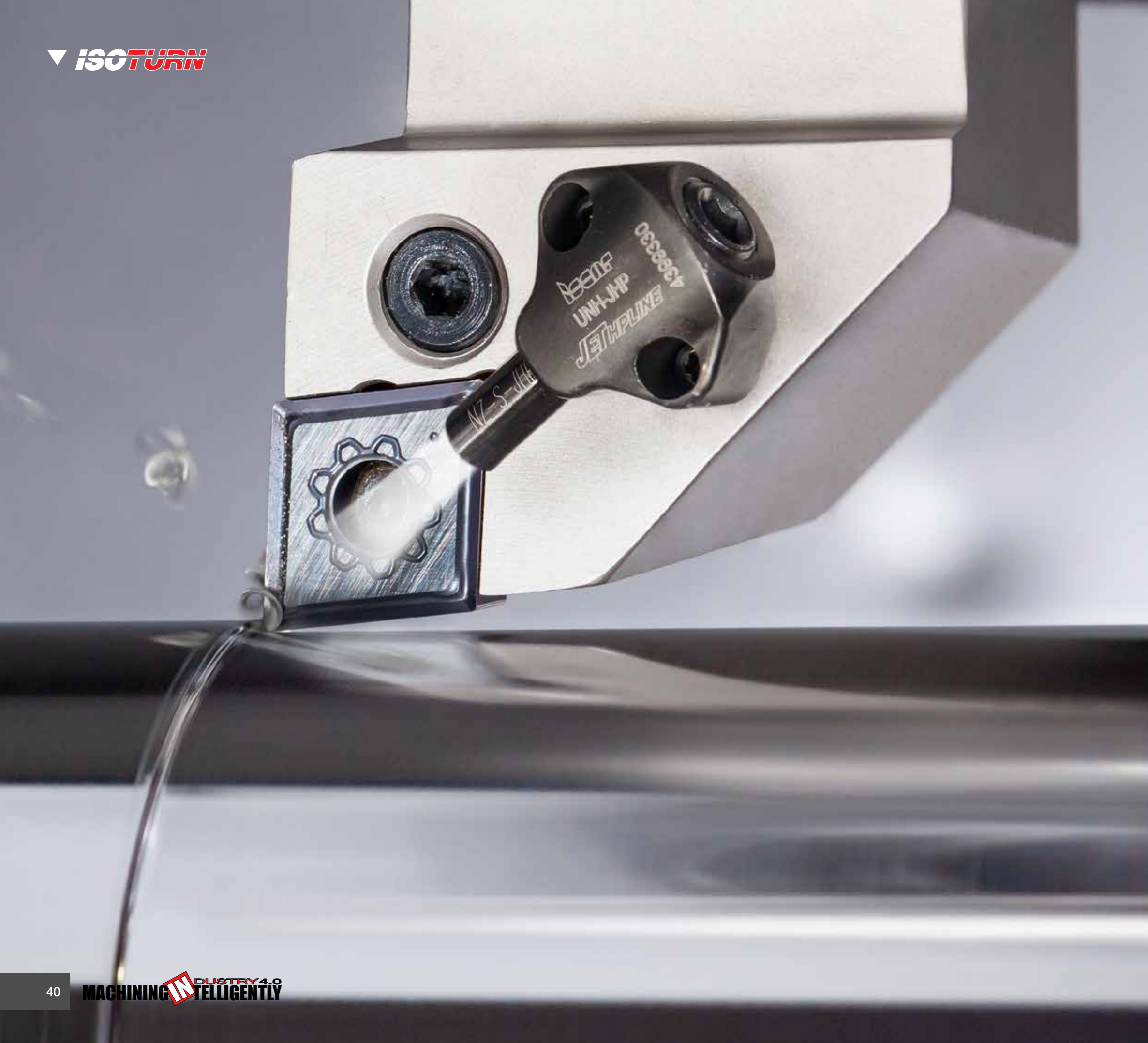

ISCAR's new chipformer F3S for finish turning exotic superalloys was designed for popular ISO-type inserts (CNMG, WNMG etc.). A typical finishing operation is characterized by shallow depth of cut and low feed. Therefore, the success of a chipformer lays in a small area that adjoins the insert cutting edge. It will take real engineering "art" and a lot of effort to redesign this area for much better performance when compared with the existing inserts.

F3S gives an example how to do this successfully. It has a reinforced cutting edge to prevent notch wear as well as a specially designed deflector for efficient chip control in finish turning HTSA. In combination with a positive rake, these features ensure a smooth and easy cut, notable chip breaking capabilities, and significant reduction in cutting forces.

NEOLOGIQ

MACHINING INTELLIGENTLY



LOGIQ3CHAM
THREE FLUTE CHAMDRILL

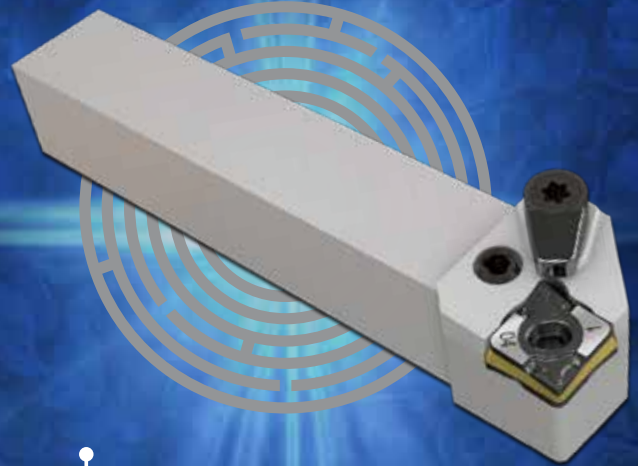

LOGIQ4TURN
POSITIVE DOUBLE SIDED

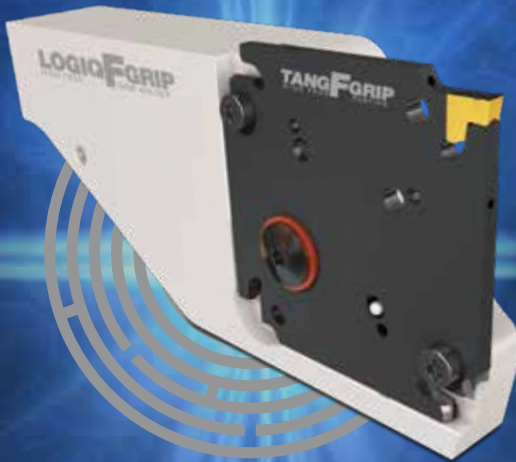

LOGIQFGRIP
HIGH FEED GRIP HOLDER



LOGIQ4FEED
HIGH FEED MILLING